

# OPAL KOMBI

Combined CO<sub>2</sub> and diode  
medical laser



Otolaryngology (ENT)



# CO<sub>2</sub> and diode laser, combined.

Three of the mostly used laser technology combined in one device. The revolutionary combination of 10600, 1470 and 980nm wavelength allows the Opal Kombi to open new possibilities for fast end efficient surgeries.

Lasram's OPAL Kombi with power levels ranging from 7 to 40W can be used with a variety of handpieces and accessories in all medical fields.

CO <sub>2</sub> laser	Diode laser
10600nm beam	980 nm beam
	1470 nm beam

Guiding laser beams of different wavelengths along a beam line requires special solutions. The guiding mirrors of the laser beam are coated with a multi-wavelength reflection (Wide Broad Reflecting) coating, which is capable of transmitting laser beams of different wavelengths with high efficiency.

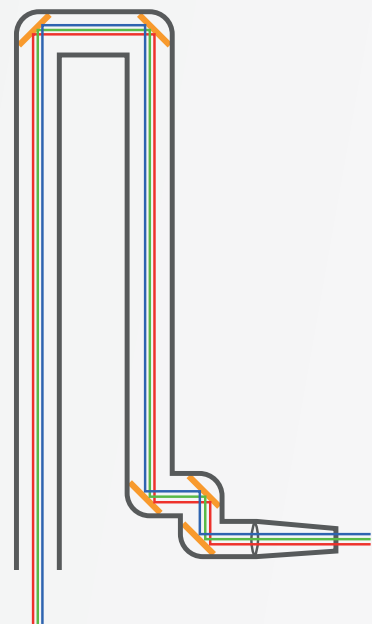

# OPAL KOMBI

State of the art performance  
with many advantages in clinical  
and outpatient practice.

## ADVANTAGES OF THE COMBINED LASERS

- Operating in the high wavelength range, it is optimally suited for the treatment of complications of COVID19 and other infections.
- Interventions that previously required multiple tools can now be easily performed.
- Because of the wide wavelength range, no other traditional surgical devices such as electro-acuters or other haemostatic solutions are needed during surgery.
- Unexpected events during surgery can be dealt with quickly and efficiently, ensuring a bleeding-free or minimal bleeding operation.
- The combination of 10600nm and 980nm technology can reduce bleeding in the event of a cut during surgery. Operating simultaneously with CO2 laser cutting, the 980nm laser can close blood vessels up to 1mm in diameter.
- By using a 980nm laser wavelength, we can treat inflamed areas. This type of irradiation can reduce the degree of inflammation.

### CO<sub>2</sub> laser operation modes (10600nm)

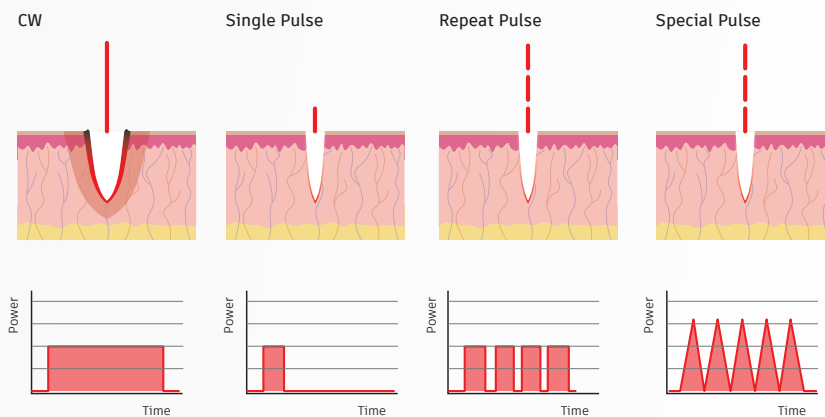

### Diode laser operation modes (980, 1470nm)

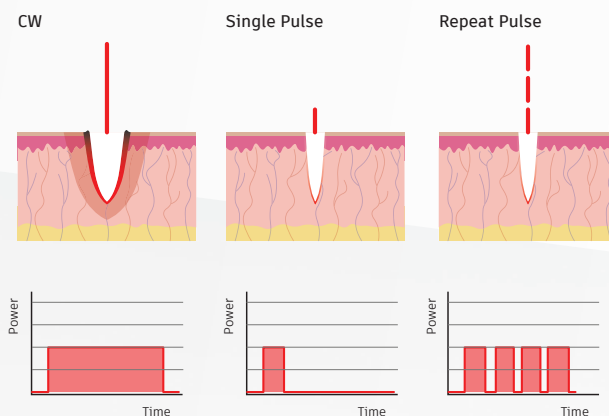

# Features

## MAIN FEATURES

- Optimal for COVID19 treatment and other infections
- CO<sub>2</sub> (1600nm) and diode (980nm) laser combined
- Option for 980 and 1470nm diode laser combination
- 0.1-0.2 µm Spot Diameter
- Spring loaded smooth arm balancing
- Tilting 9" color touchscreen
- For all medical areas

*Three laser technology in one package. The Lasram Kombi laser system is a compact, ergonomic device in a modern shape with user friendly operation.*



## S p e c i f i c a t i o n s

Laser source	DC excited CO <sub>2</sub> and diode laser sources
Wavelength (CO <sub>2</sub> )	10600nm
Wavelength (Diode)	980nm, 1470nm
Power on tissue	0.1-40W
Power on tissue (Super Pulse)	0.4-12W/0.6-18W
Operating modes (CO <sub>2</sub> )	Continuous (CW), Single pulse, Repeat pulse, Special pulse, Super pulse
Operating modes (Diode)	Continuous (CW), Single pulse, Repeat pulse,
Aiming beam	3mW 635nm diode laser
Beam delivery arm	7 joint articulated, spring balanced, 1300mm radius
Cooling	Air
Operating panel	9" tiltable color touchscreen LCD display
Memory	5 freely programmable + scanner parameters
Power supply input	230V, 50Hz, 4A, PE
Weight	45kg
Dimensions	Width: 375mm, Depth: 475mm, Height: 1150/1970mm

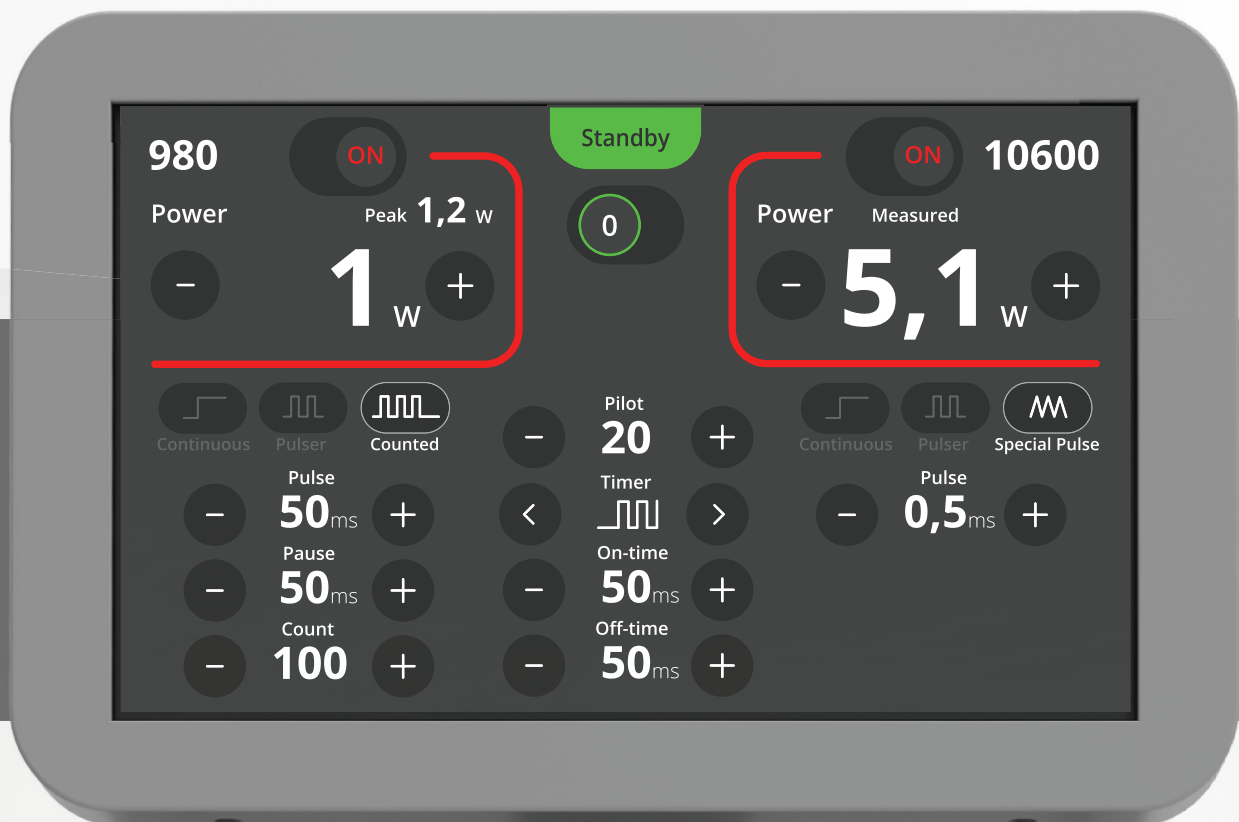

*The user interface has been designed to be clear and intuitive, so that the surgeon can focus on the procedure. The simple and modern design is appealing on the tilting 9" touchscreen display with wide viewing angle IPS technology.*

# Otolaryngology (ENT)

Laser treatment is a minimally invasive way to treat a variety of ear, nose and throat conditions.

The high degree of precision of the CO<sub>2</sub> laser combined with the excellent haemostatic effect of the diode laser makes the ENT procedures effective and reduces the patient's recovery time.

## APPLICATIONS

- Micro-surgical treatments of benign/malign
- Laser stapedotomy, stapedectomy
- Tonsillotomy, tonsillectomy
- Facial leisions
- Soft plate surgery (LAUP)

Treatment of lingual root lesions (before procedure)

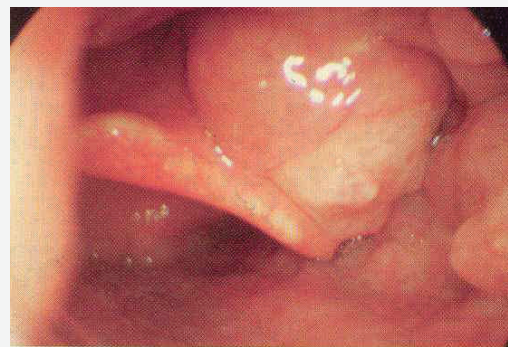

Post-operative condition

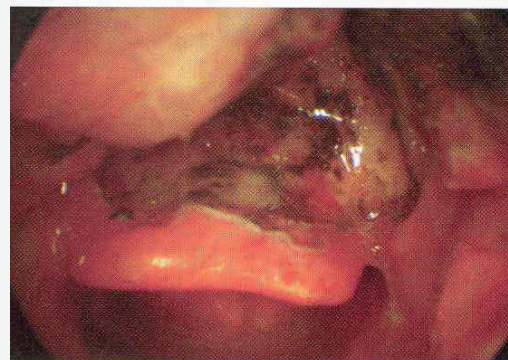

Satisfying result after the properly recovered condition

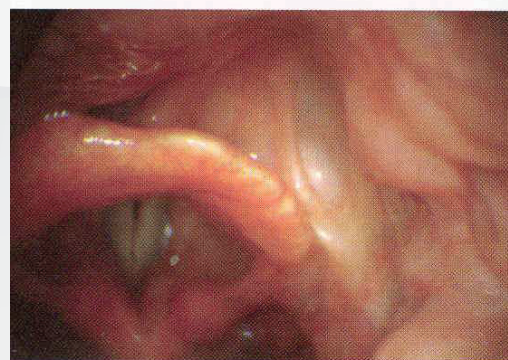

## ACCESSORIES FOR OTOLARYNGOLOGY

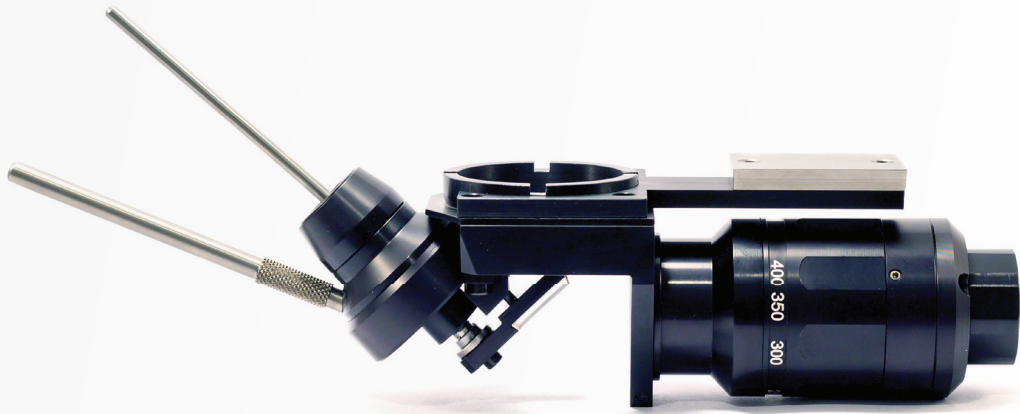

Mm-91 Micromanipulator  
2HP10-90000

### Standard handpieces



100 mm focal length  
2HP10-90000



200 mm focal length  
2HP20-90000

### ENT (Ear-Nose-Throat) handpieces

Full ENT set  
2ENT3-90000



ENT optical unit  
2ENT3-91000



0° end piece  
2ENT3-92000



90° end piece  
2ENT3-93000



120° end piece  
2ENT3-94000

### Tips



90° angled tip  
(for 127 mm and 200 mm handpiece)  
2AT09-90000



120° angled tip  
(for 127 mm, and for 200 mm handpiece  
with ADT adapter)  
2AT12-90000



Backstop 127  
(for 127 mm handpiece)  
2BS12-90000



Backstop 200  
(for 200 mm handpiece)  
2BS20-90000



ADT adapter  
(for angled tips with 200 mm handpiece)  
2ADT0-90000

# OPAL KOMBI

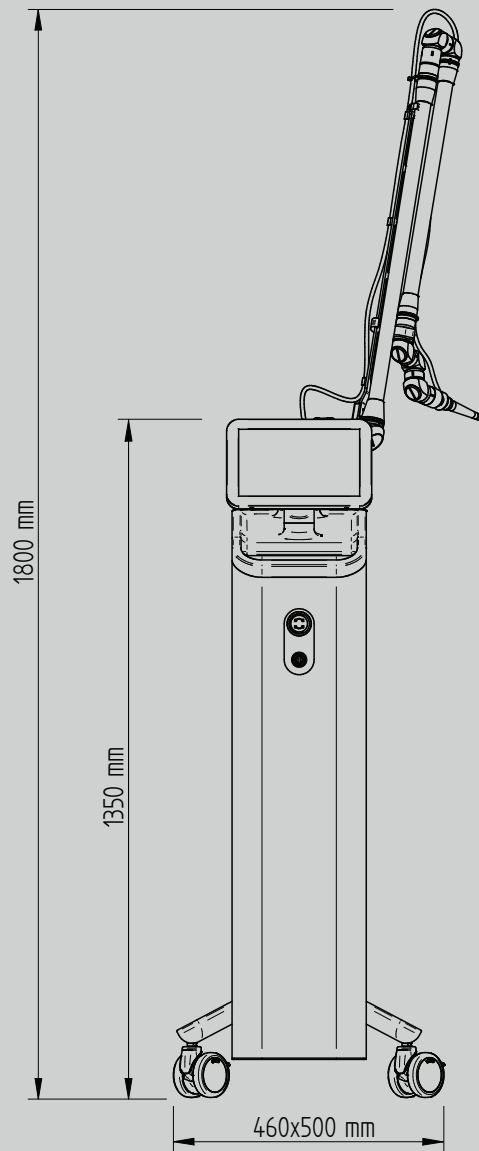

## About Lasram

Lasram is a European medical and industrial laser system developer and manufacturer company, based in Hungary and Germany. Lasram products are developed, tested and manufactured according to the international standards. The company is EN ISO 9001:2015 and EN ISO 13485:2016 certified and has EN ISO 14001:2015 environmental management certificate.

### HUNGARY

H-1044 Budapest  
Ezred utca 2. B2/2  
Tel: +36-1-688 1910

H-2500 Esztergom  
Mátyás Király utca 44.  
Tel: +36-33-501 015

### GERMANY

D-85774 Unterföhring  
Münchner Str. 18.  
Tel: +49-89-2441 3103



© 1991-2024 All rights reserved. This marketing material includes trademarks. Lasram and Opal Kombi brand and it's logos are trademarks of Lasram Engineering LTD. Specifications are subject to change without notice.

**LASRAM**

[WWW.LASRAM.HU/MEDICAL-LASERS](http://WWW.LASRAM.HU/MEDICAL-LASERS)